

MOUNT KITS

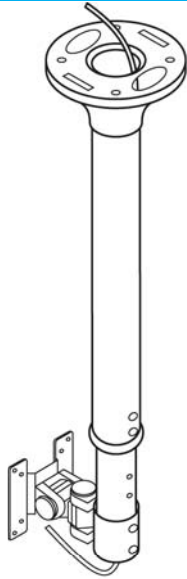

Ceiling Pole Mount GPU-8730B

- Adjustable length: 600 mm to 1060 mm
- Adjustable screen tilt, swivel & rotate
- Firmly fixes on the ceiling
- Holds POS/monitor up to total weight of 20 kg
- VESA 75 x 75 / 100 x 100 mm

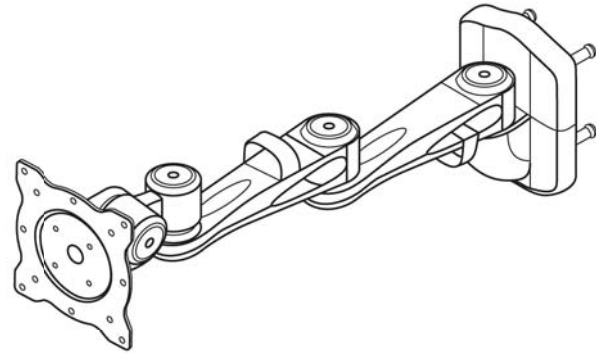

Swing Arm GPU-262BS

- Mount POS/monitor onto the wall with a 45 cm long adjustable aluminium die-cast arm
- Adjustable screen tilt, swivel & rotate
- Holds POS/monitor up to total weight of 15 kg
- VESA 75 x 75 / 100 x 100 mm

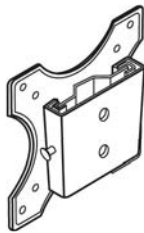

Wall Mount bracket (flat) GPU-1150C

- Thin wall mounting (15 mm from wall)
- Firmly fixes onto the wall
- Holds POS/monitor up to total weight of 12 kg
- VESA 75 x 75 / 100 x 100 mm

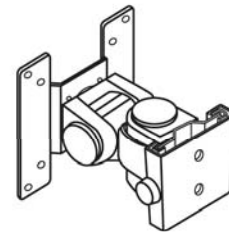

Wall Mount bracket GPU-WM117B

- Deluxe wall mounting (130 mm from wall)
- Adjustable screen tilt, swivel & rotate
- Firmly fixes onto the wall
- Holds POS/monitor up to total weight of 12 kg
- VESA 75 x 75 / 100 x 100 mm

The Senor Building

65 & 67 Weaver Street
Coopers Plains
QLD 4108, Australia

www.senortech.com.au

P: +61 7 3275 5888
sales@senortech.com.au

SENIOR
TOUCH SCREEN SOLUTIONS

Quality. Safety. Versatility.

MOUNT KITS

Max Mount Pole
total length: 600 mm

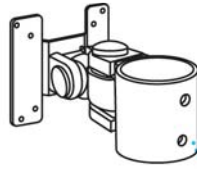

Main Screen Bracket
Adjustment: tilt, swivel & rotate
66B-400



Main Screen Bracket
Adjustment: tilt, rotate
61B-200

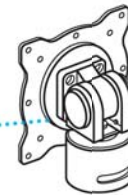

Top-tilt Bracket
Adjustment: tilt, rotate
61B-100

Vertical Printer Carrier
Adjustment: tilt, rotate
61B-200P

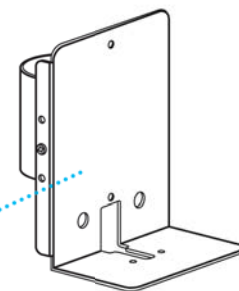
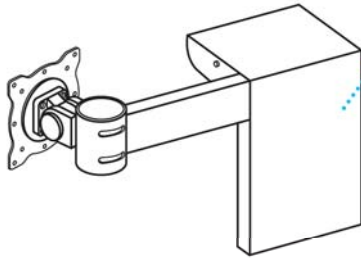

Scanner Carrier
61B-300

Keyboard Holder
61B-499



Horizontal Printer Carrier
61B-300PL (left)
61B-300PR (right)

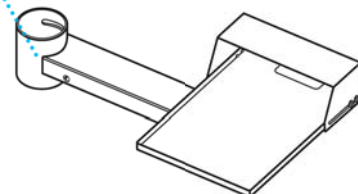

The Senor Building
65 & 67 Weaver Street
Coopers Plains
QLD 4108, Australia
www.senortech.com.au

P: +61 7 3275 5888
sales@senortech.com.au

SENIOR
TOUCH SCREEN SOLUTIONS

Quality. Safety. Versatility.